

TOPI

PREPOSICIÓN

SIN



JUEGO DE CARTAS

© 2020

La web de Antonia Ortega
www.webantoniaortega.com

INSTRUCCIONES

1.- Imprimir tablero y cartas.

Tenemos cartas de dos tamaños , debemos de ver el tamaño que nos interesa en función de la agudeza visual del destinatario.

2.- Recortar las 36 cartas.

3.- Se barajan las cartas y debemos encontrar las parejas.

4.- Colocar las cartas en el tablero, una vez halladas, en el recuadro correcto diciendo cuál es la preposición que se usa: con o sin.

JUEGO DE CARTAS

Cartas

CON

Cartas

SIN



CARTAS TAMAÑO PEQUEÑO



Sin paraguas.



Con paraguas.

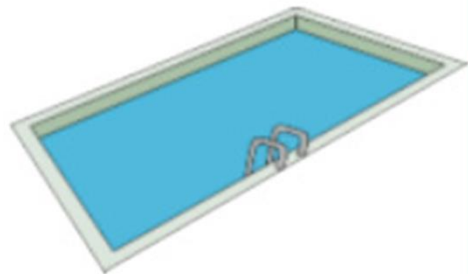

Con agua.

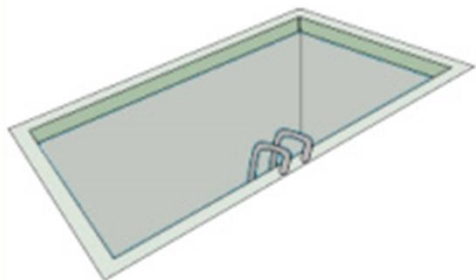

Sin agua.



Sin bolas.



Con bolas



Sin agua.



Con agua.



Con gafas.



Sin gafas.

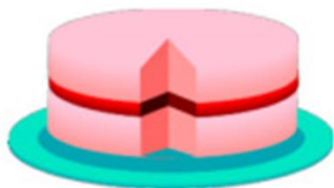

Sin velas.



Con velas.



Con pájaro



Sin pájaro.



Con pez.



Sin pez.



Sin pelota.



Con pelota.



Con caramelos.



Sin caramelos.



Con sombrero.



Sin sombrero.



Sin fruta.



Con fruta.



Con hojas.



Sin hojas.



Con sombrero.



Sin sombrero.



Sin pájaro.



Con pájaro.



Con hilo.



Sin hilo.



Con patatas.



Sin patatas.



Sin agujas.



Con agujas.

CARTAS TAMAÑO GRANDE



Sin paraguas.



Con paraguas.

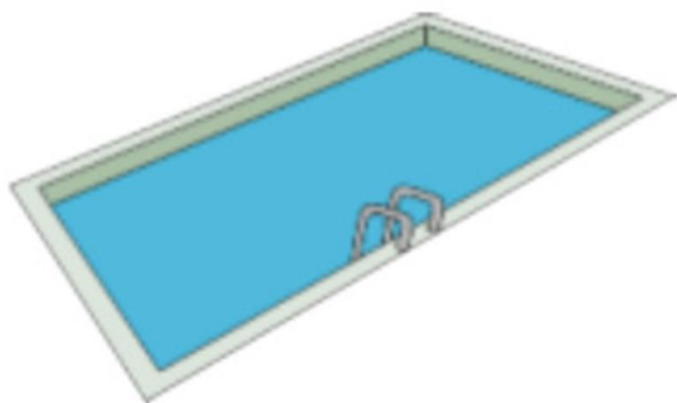

Con agua.

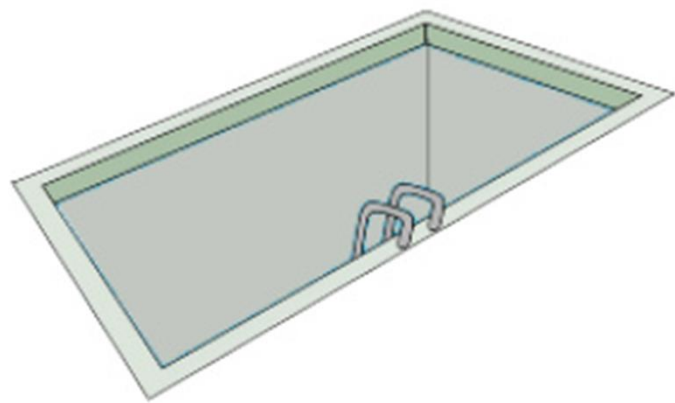

Sin agua.



Sin bolas.



Con bolas



Sin agua.



Con agua.



Sin gafas.



Con gafas.

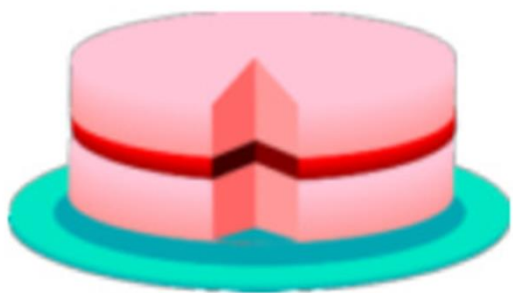

Sin velas.



Con velas.



Con pájaro



Sin pájaro.



Con pez.



Sin pez.



Sin pelota.



Con pelota.

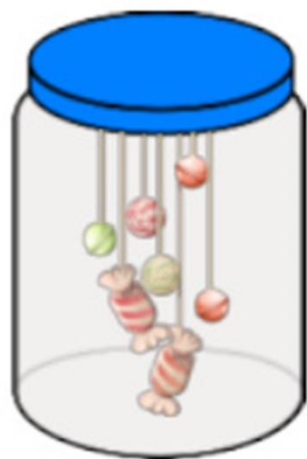

Con caramelos



Sin caramelos.



Con sombrero.



Sin sombrero.



Sin fruta.



Con fruta.



Con hojas.



Sin hojas.



Con sombrero.



Sin sombrero.



Sin pájaro.



Con pájaro.



Sin hilo.



Con hilo.



Sin patatas.



Con patatas.



Sin agujas.



Con agujas.